



全本公示稿

.....

.....

.....

.....

.....

.....

.....

.....

1

1.1

682

44

<

>

1

"

61

50

"

1.2

1.3

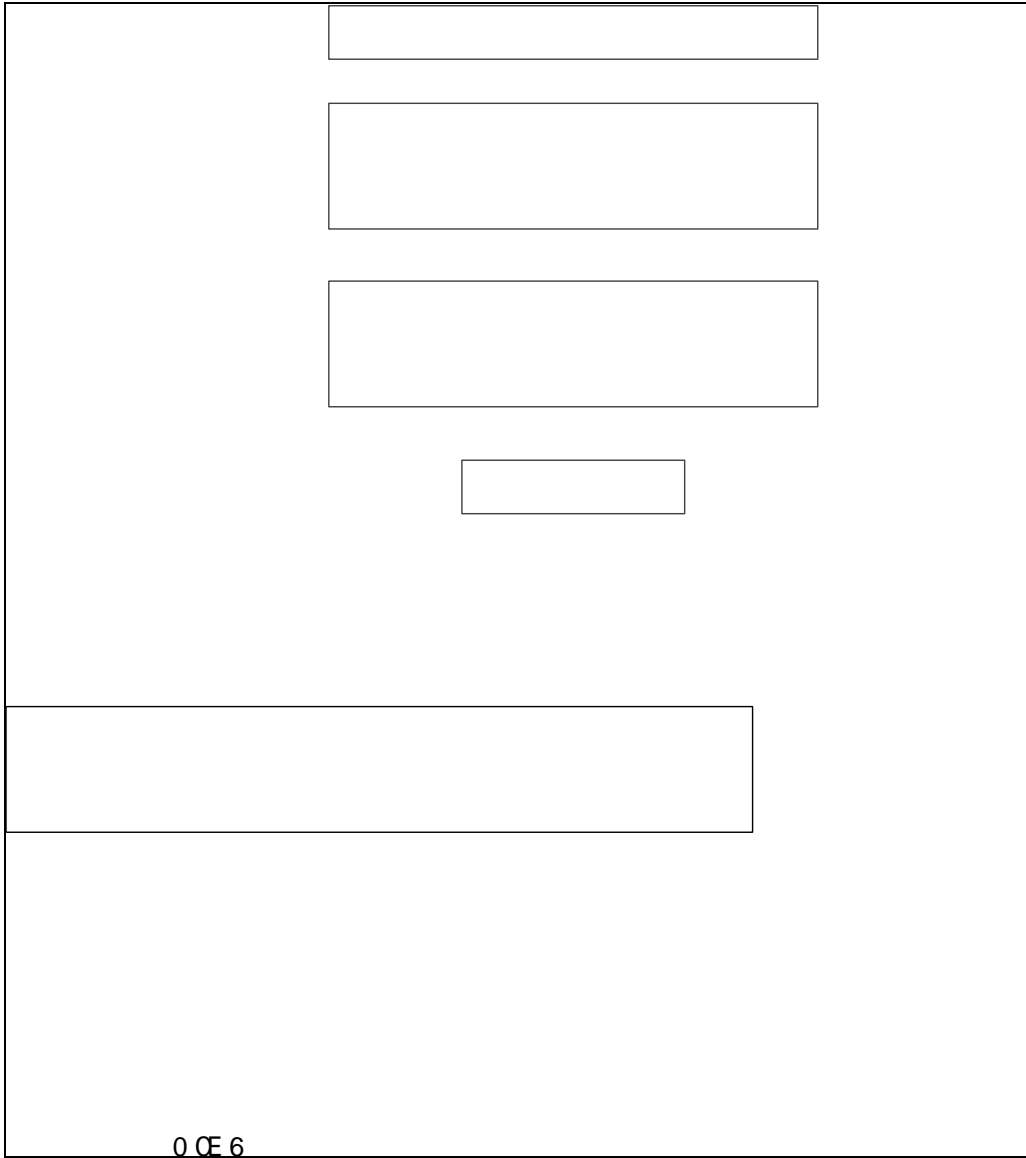

1.4

1.4.1

2019-340504-31-03-019937

1.4.2

1.4.3

1.4.4

1.4.5

1.4.6

1.4.7

| | | |
|------|--|--|
| | | |
| | | |
| | | |
| VOCs | | |

1.4.8

1.5

1.6

“ ”

2

2.1

2.1.1

| | | | | | | | | | |
|-----------|----|---|------|------|----|------|------|------|--|
| 1 | | | | | | | | | |
| 2 | | | 2018 | 12 | 29 | | | | |
| 3 | | | 2018 | 10 | 26 | | | | |
| 4 | | | 2017 | 6 | 27 | | | | |
| 5 | | | 2018 | 12 | 29 | | | | |
| 6 | | | | 2019 | 6 | 5 | | | |
| 7 | | | | | | | | | |
| 8 | | | | 682 | | 2017 | 10 | 1 | |
| 9 | | | 2019 | | | | | | |
| 10 | | | | 2012 | | | | | |
| 2012 | | | 2012 | 98 | | | | | |
| 11 | | | | | | 4 | 2019 | 1 | |
| 1 | | | | | | | | | |
| 12 | | | | | | | 1 | 2018 | |
| 4 | 28 | | | | | | | | |
| 13 | | | | | | | 2013 | 37 | |
| 14 | | | | | | | | | |
| 15 | | | | | | | | | |
| [2014]30 | | | | | | | | | |
| 16 | | | | | | | 2015 | 17 | |
| 17 | | < | | | | | | > | |
| [2013]103 | | | | | | | | | |
| 18 | | | | | | | | | |

[2014]197

19

2.1.3

2.1.4

2.2

2.2.1

| | | |
|--|--|--|
| | | |
| | | |
| | | |
| | | |
| | | |
| | | |
| | | |



| | | | | |
|-----------------|---|-----|---|-----------------|
| O ₃ | 8 | 160 | 3 | HJ2.2-2018 D |
| NH ₃ | 1 | 200 | 3 | |
| HCl | 1 | 50 | | |

| | | | | |
|---|--------------------|------|-------------|--|
| | | | | |
| 1 | pH | 6~9 | GB3838-2002 | |
| 2 | COD | 20 | | |
| 3 | | 0.05 | | |
| 4 | NH ₃ -N | 1.0 | | |
| 5 | TP | 0.2 | | |
| 6 | SS | 30 | SL63-94 | |

| | | | |
|---|----|----|-------------|
| | | | |
| 3 | 65 | 55 | GB3096-2008 |

| | | | | | |
|--|-----|---------|----|--|--|
| | | | | | |
| | pH | 6.5 8.5 | 9 | | |
| | | | 10 | | |
| | | | 11 | | |
| | | | 12 | | |
| | | | 13 | | |
| | | | 14 | | |
| | () | | 15 | | |
| | | | 16 | | |

| | | | | | |
|----|-------|-------|----|------|------|
| | | | | | |
| 1 | | 60 | 25 | | 0.43 |
| 2 | | 65 | 26 | | 4 |
| 3 | | 5.7 | 27 | | 270 |
| 4 | | 18000 | 28 | 1,2- | 560 |
| 5 | | 800 | 29 | 1,4- | 20 |
| 6 | | 38 | 30 | | 28 |
| 7 | | 900 | 31 | | 1290 |
| | | | 32 | | 1200 |
| 8 | | 2.8 | 33 | + | 570 |
| 9 | | 0.9 | 34 | | 640 |
| 10 | | 37 | | | |
| 11 | 1,1- | 9 | 35 | | 76 |
| 12 | 1,2- | 5 | 36 | | 260 |
| 13 | 1,1- | 66 | 37 | 2- | 2256 |
| 14 | -1,2- | 596 | 38 | [a] | 15 |
| 15 | -1,2- | 54 | 39 | [a] | 1.5 |
| 16 | | 616 | 40 | [b] | |

| | | | | |
|---|---|--|-----|--|
| | | | | |
| 1 | | | 15 | |
| | | | 30 | |
| 2 | | | 15 | |
| | | | 30 | |
| 3 | * | | 20 | |
| 4 | | | 150 | |
| 5 | | | 300 | |

| | | |
|---|--|-----|
| | | |
| 1 | | 5.0 |
| 2 | | 0.2 |

| | | |
|---|--------------------|-----|
| | | |
| 1 | pH | 6~9 |
| 2 | COD | 70 |
| 3 | SS | 30 |
| 4 | | 3 |
| 5 | NH ₃ -N | 5 |
| 6 | TP | 0.5 |
| 7 | * | 10 |

| | | |
|---|----|----|
| | | |
| 3 | 65 | 55 |

2.3

2.3.1.1

| | |
|--|-------------|
| | |
| | |
| | 1% Pmax 10% |
| | Pmax 1% |

| | | | | | | |
|------|--|------------------|-----|--------|--------|---|
| | | | | | | |
| | | PM ₁₀ | 450 | 4.0834 | 0.9074 | / |
| 1720 | | TSP | 900 | 3.3162 | 0.3685 | / |

1%

HJ2.2-2018

HJ2.2-2018 5.3.3.2"

2.3.1.2

2.3.1.3

2.3.1.4

| | | | |
|--|--|--|--|
| | | | |
| | | | |
| | | | |
| | | | |

2.3.1.5

2.3-3

| | | | | | | | | | |
|---|--|--|--|--|--|--|--|---|---|
| | | | | | | | | | |
| | | | | | | | | | |
| | | | | | | | | | |
| | | | | | | | | | - |
| | | | | | | | | - | - |
| - | | | | | | | | | |

2.3.1.6

| | | | | |
|---|--|--|--|---|
| | | | | |
| | | | | a |
| a | | | | |

2.3.1.7

| | | | | |
|---|--|--|--|-----|
| | | | | |
| 1 | | | | 5km |
| 2 | | | | |

2.4

| | | | | | | | | |
|--|--|--------|---------|--|------|----|------|-------------------|
| | | | | | | | | |
| | | | | | | | | |
| | | 639456 | 3506032 | | 4400 | E | 380 | (GB3095 -2012) |
| | | 638046 | 3506237 | | 620 | W | 920 | |
| | | 637949 | 3505930 | | 260 | W | 1050 | |
| | | 637532 | 3505753 | | 80 | W | 1530 | |
| | | 638797 | 3505288 | | 3800 | S | 815 | |
| | | 638461 | 3504612 | | 2620 | S | 1540 | |
| | | 638781 | 3504360 | | 160 | S | 1870 | |
| | | 639686 | 3505729 | | 340 | SE | 760 | |
| | | 640160 | 3506327 | | 1250 | E | 950 | |
| | | 640234 | 3505947 | | 2400 | E | 1120 | |
| | | 640258 | 3505304 | | 1200 | SE | 1380 | |
| | | 640217 | 3504771 | | 1600 | SE | 1740 | |
| | | 640262 | 3504242 | | 2100 | SE | 2160 | |
| | | 641021 | 3507804 | | 800 | NE | 2920 | |
| | | 640687 | 3507151 | | 2100 | NE | 1790 | |
| | | 641035 | 3506652 | | 1300 | E | 1870 | |
| | | 640356 | 3506664 | | 1150 | E | 1480 | |
| | | 640877 | 3506672 | | 800 | E | 1760 | |
| | | 641059 | 3506357 | | 2200 | E | 1940 | |
| | | 641137 | 3505999 | | 1300 | E | 1870 | |
| | | 640596 | 3505963 | | 2200 | E | 1510 | |
| | | 640631 | 3505327 | | 800 | SE | 2150 | |
| | | 641075 | 3505358 | | 1140 | SE | 1730 | |
| | | 640646 | 3504765 | | 3200 | SE | 1960 | |
| | | 641133 | 3504272 | | 2500 | SE | 2800 | |

| | | | | |
|--|--|------|---------------------|------------------|
| | | | | |
| | | W | 1750 | (GB3838-2002) |
| | | | 4.33km ² | (GB/T14848-2017) |
| | | | 0.05km | (GB36600-2018) |
| | | 200m | | (GB3096-2008) 3 |

| | | | | | | | |
|--|--|--------|---------|--|------|----|------|
| | | | | | | | |
| | | | | | | | |
| | | 639456 | 3506032 | | 4400 | E | 380 |
| | | 638046 | 3506237 | | 620 | W | 920 |
| | | 637949 | 3505930 | | 260 | W | 1050 |
| | | 637532 | 3505753 | | 80 | W | 1530 |
| | | 638797 | 3505288 | | 3800 | S | 815 |
| | | 638461 | 3504612 | | 2620 | S | 1540 |
| | | 638781 | 3504360 | | 160 | S | 1870 |
| | | 639686 | 3505729 | | 340 | SE | 760 |
| | | 640160 | 3506327 | | 1250 | E | 950 |
| | | 640234 | 3505947 | | 2400 | E | 1120 |
| | | 640258 | 3505304 | | 1200 | SE | 1380 |
| | | 640217 | 3504771 | | 1600 | SE | 1740 |
| | | 640262 | 3504242 | | 2100 | SE | 2160 |
| | | 641021 | 3507804 | | 800 | NE | 2920 |
| | | 640687 | 3507151 | | 2100 | NE | 1790 |
| | | 641035 | 3506652 | | 1300 | E | 1870 |
| | | 640356 | 3506664 | | 1150 | E | 1480 |
| | | 640877 | 3506672 | | 800 | E | 1760 |
| | | 641059 | 3506357 | | 2200 | E | 1940 |
| | | 641137 | 3505999 | | 1300 | E | 1870 |
| | | 640596 | 3505963 | | 2200 | E | 1510 |
| | | 640631 | 3505327 | | 800 | SE | 2150 |
| | | 641075 | 3505358 | | 1140 | SE | 1730 |
| | | 640646 | 3504765 | | 3200 | SE | 1960 |
| | | 641133 | 3504272 | | 2500 | SE | 2800 |
| | | 640673 | 3503717 | | 680 | SE | 2900 |
| | | 640250 | 3503597 | | 800 | SE | 2810 |
| | | 638765 | 3503297 | | 2800 | S | 2870 |
| | | 639138 | 3502566 | | 220 | S | 3590 |
| | | 639278 | 3501690 | | 130 | S | 4500 |
| | | 636928 | 3501707 | | 40 | SW | 3920 |
| | | 634921 | 3503205 | | 80 | SW | 4800 |
| | | 640411 | 3510761 | | 720 | N | 4800 |

(GB3095-2012)

2.5

2.5.1

3

3.1

3.1.1

3.1.2

3.1.3

| | | |
|--|------|--------|
| | | |
| | CQ | 106.96 |
| | DQ | 19.86 |
| | DDQ | 15.28 |
| | HSLA | 10.70 |
| | | 152.8 |

3.1.4

| | | | | | | | | | |
|--|------|-------------------|-------------------|-------------------|------------------|-------------------|----------------------|-----------------------|-----------------------|
| | | | | | | | | | |
| | 1720 | 1720 | - | | | | | 7530m ² | 1 |
| | | | | | | | 152.8 | t | |
| | | | | | | | 1800m ² | | 1 |
| | | | | | | | | | 18m ³ /min |
| | | 1720 | | | | | | | |
| | | | | | | | 8.5m ³ /h | | |
| | | | | | | | | | 1200m ² |
| | | | | | | | 5400m ² | | |
| | | | | | | | 3900m ² | | |
| | | | | | | | 200m ² | | |
| | | | | | | | 1200m ² | 10 | 2 |
| | | 1 | 150m ³ | | 2 | 150m ³ | 60m ³ | 2 | 150m ³ |
| | | 150m ³ | | 150m ³ | 40m ³ | | 150m ³ | | 2 |
| | | | | | | | | | |
| | | | | | | | | 3000m ³ | |
| | | | | | | | 25m ³ /h | | |
| | | | 301 | | | | | 1560m ³ /h | |
| | | | | | | | | | |
| | | | | | | | 20m ³ /h | | |
| | | | | | | | 8m ³ /d | | |
| | | | | | | | | | |
| | | | | | | | 2 | | 7800 kWh |
| | | | | | | | | | |
| | | | | | | | | 6.5t/h | 80 |
| | | | | | | | | | |
| | | | | | | | | | 6450m ³ /h |
| | | | | | | | | | |
| | | | | | | | | | 1200m ³ /h |

| | | | |
|-------|-------|---------------|---|
| | | | |
| 1# 2# | 39m | 4×28t | 2 |
| | / | | 1 |
| | / | | 1 |
| 1# 2# | / | | 2 |
| | / | | 2 |
| | / | | 2 |
| | / | | 2 |
| | | 1m | 1 |
| | | NMW-C | 1 |
| | / | | 2 |
| | / | | 1 |
| 3# | 4 | | 1 |
| | | | 1 |
| | / | | 6 |
| | / | | 8 |
| | / | | 1 |
| | | 45t | 1 |
| | 122m | 1.45m | 1 |
| | 18m | 1.95m 2.8m | 1 |
| | 5m | 2.3m 1.6m | 1 |
| | / | | 1 |
| | | 780MPa | 1 |
| | | 188mm | 1 |
| | / | | 1 |
| | | | |
| | 1#-4# | UCM | 1 |
| | / | | 1 |
| | / | | 1 |
| | / | | 2 |
| | / | | 2 |
| | / | | 1 |
| | / | | 1 |
| | / | | 1 |

3.1.7

3.1.7.1

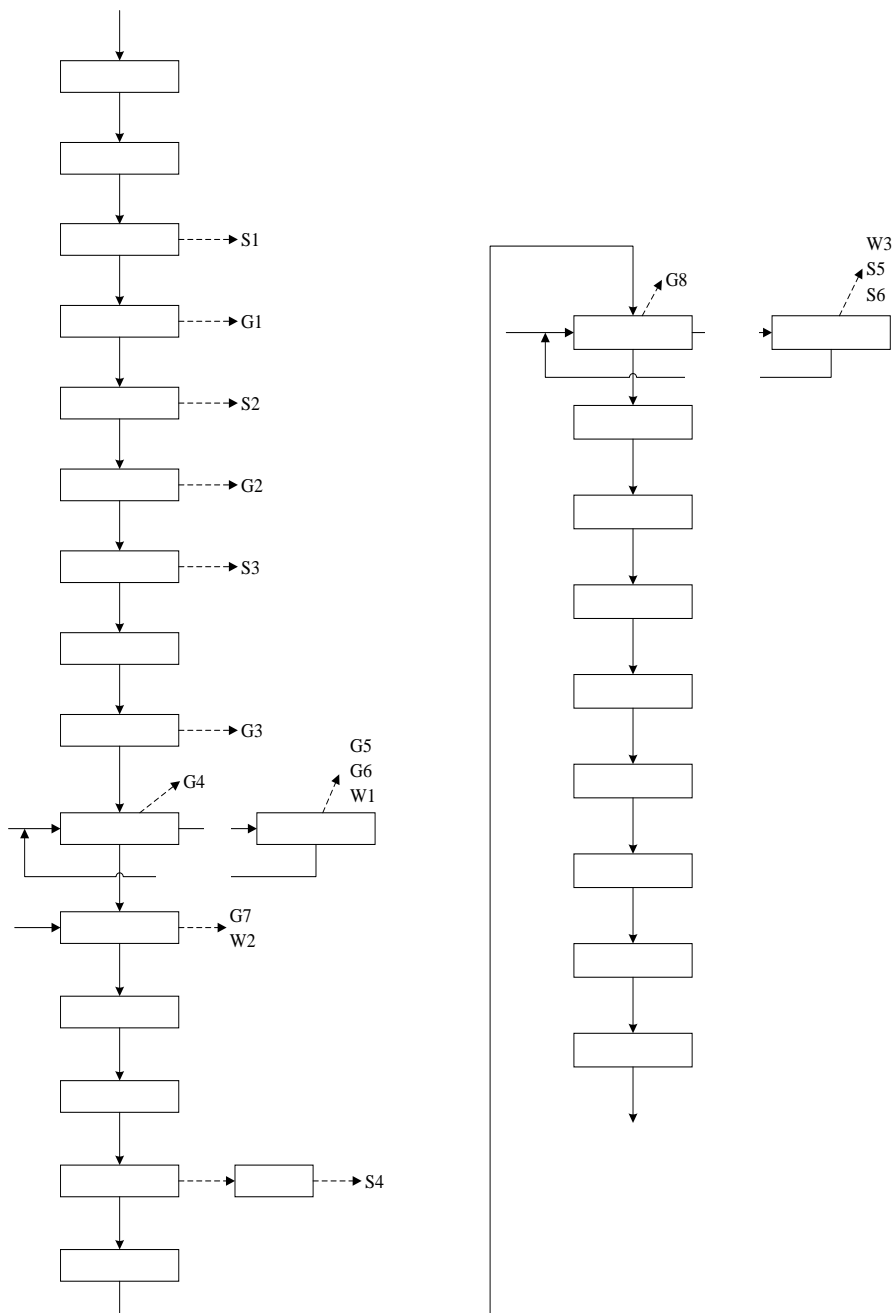

3.1.7.2

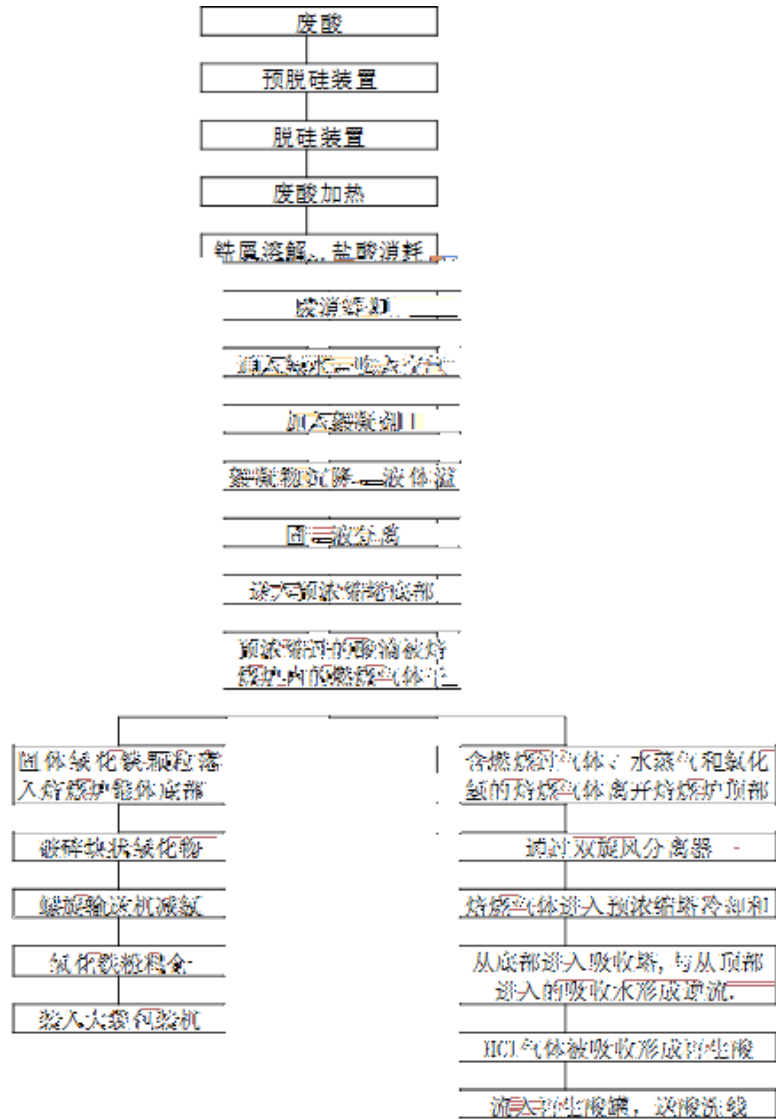

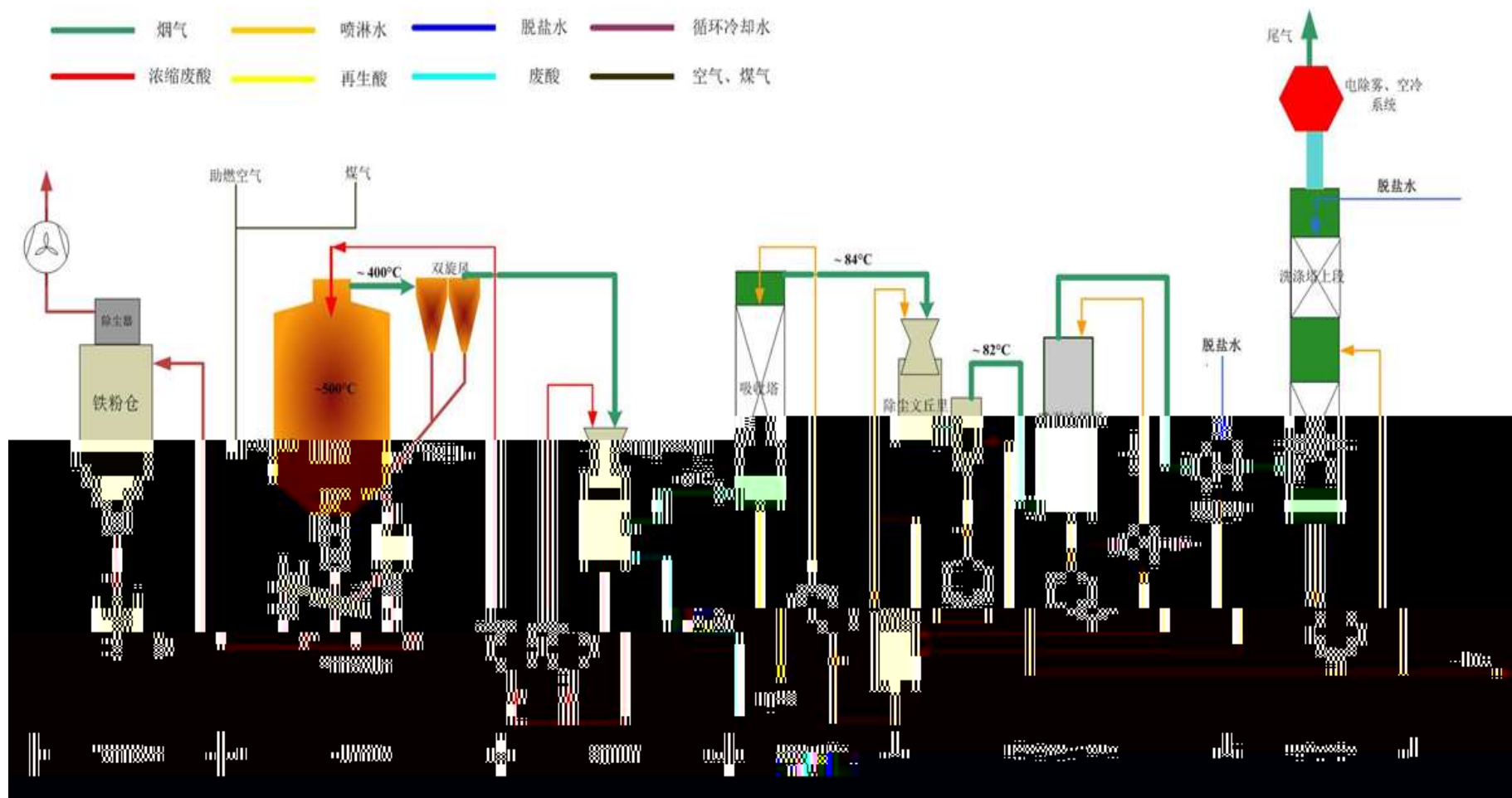



3.2

3.2.1

3.2.1.1

| | | | | |
|--|--|--|--|---------------------------|
| | | | | |
| | | | | |
| | | | HCl | +30m |
| | | | | +27m |
| | | | HCl SO ₂ NO _x | + +40m |
| | | | | +12m |

3.2.1.2

| | | | | | |
|--|--|-----------|--|-------|------|
| | | | | | |
| | | 2019.3.28 | | 14940 | 9.42 |
| | | | | 16597 | 10.9 |
| | | | | 12744 | 8.12 |

| | | | | | | |
|--|--|----------|--|-------|-----|------|
| | | | | | | |
| | | 2019.9.5 | | 18314 | 2.8 | 18.7 |
| | | | | 18283 | 3.9 | 20.9 |
| | | | | 18987 | 3.4 | 20.7 |

| | | | | | |
|--|--|-----------|--|------|-----|
| | | | | | |
| | | 2019.5.28 | | 9751 | 7.8 |
| | | | | 9288 | 8.4 |
| | | | | 9012 | 5.6 |

| | | | | | |
|----------------------|--|-------------|-------------|-------------|-----|
| | | | | | |
| | | 0.292~0.324 | 0.383~0.416 | 0.331~0.367 | 5.0 |
| 2019.10.11~ 10.12 | | 0.07~0.12 | 0.08~0.17 | 0.10~0.14 | |

3.2.1.3

| | | | | | |
|--|--|---|-------|--|-------|
| | | | | | |
| | | / | 0.02S | | 0.02S |
| | | / | 8.6 | | 8.6 |

4#

| 1# | | 1.5 | HCl | 12.1 | 0.181 | 1.412 |
|----|--|-----|-----------------|------|-------|-------|
| 2# | | 24 | | 5.3 | 1.066 | 8.316 |
| 3# | | 1.9 | HCl | 20.7 | 0.393 | 3.065 |
| | | | | 3.8 | 0.071 | 0.556 |
| | | | SO ₂ | 35.7 | 0.678 | 5.29 |
| | | | NO _x | 40.7 | 0.774 | 6.038 |
| 4# | | 1 | | 7.8 | 0.078 | 0.608 |

| | | | | M | P (Pa) | D (m) | H (m) | ΔT () | F _P | C | K _c | K _N |
|-----|---|-------------------|----|-------|-----------|----------|----------|----------------|----------------|------------|----------------|----------------|
| 32% | 2 | 150m ³ | | 36.46 | 3133 | 6 | 5.6 | 12 | 1.25 | 0.88 93 | 1 | 1 |
| | | 60m ³ | | | | 4.2 | 4.5 | | | | | |
| 18% | 2 | 150m ³ | 80 | 36.46 | 1146 | 6 | 5.6 | 12 | 1.25 | 0.88 93 | 1 | 0.2 7 |
| 25% | 1 | 40m ³ | | 35.05 | 1590 | 3.6 | 4.2 | 12 | 1.25 | 0.58 62 | 1 | 1 |

| | | | | | |
|---|--|------|-----------------|-------|-------|
| | | | | | |
| 1 | | 1720 | | 2.74 | 24 |
| 2 | | | | 0.192 | 1.68 |
| 3 | | | | 0.010 | 0.084 |
| 4 | | | | 0.017 | 0.15 |
| 5 | | | HCl | 0.046 | 0.402 |
| 6 | | | NH ₃ | 0.003 | 0.027 |

3.2.2

| | | | | |
|--|--|--|------------------------------|-----|
| | | | | |
| | | | pH COD SS | 301 |
| | | | | |
| | | | COD SS NH ₃ -N | |

| | | | | |
|-----|------------|-----|------|-----|
| | | | | |
| 301 | 2018-10-30 | pH | 7.27 | 6~9 |
| | | COD | 33 | 70 |
| | | | 8 | 30 |
| | | | 1 | 5 |
| | | | 0.06 | 3 |

| | | | | | |
|--|--|--------------------|----------------------|--------|-----|
| | | | | | |
| | | | | | |
| | | | 288m ³ /d | | 301 |
| | | pH | 2~4 | | |
| | | COD | 1500 | 0.432 | |
| | | SS | 800 | 0.230 | |
| | | | 2000 | 0.576 | |
| | | | 192m ³ /d | | |
| | | COD | 8000 | 1.536 | |
| | | SS | 3000 | 0.576 | |
| | | | 15000 | 2.88 | |
| | | | 8m ³ /d | | |
| | | COD | 350 | 0.003 | |
| | | NH ₃ -N | 25 | 0.0002 | |
| | | SS | 250 | 0.002 | |

3.2.3

20~25dB(A)

3.2.4

GB34330-2017

2016

| | | | | | |
|---|--|--|-------|--|--|
| | | | | | |
| 1 | | | 62000 | | |
| 2 | | | 10000 | | |
| 3 | | | 18.25 | | |

| | | | | | | | | | | |
|---|--|------|-----|--|--|--|--|---|------|--|
| | | | | | | | | | | |
| 1 | | HW08 | 320 | | | | | 3 | T I | |
| 2 | | HW49 | 150 | | | | | | T/In | |
| 3 | | HW49 | 2.5 | | | | | | T/In | |
| 4 | | HW08 | 25 | | | | | | T I | |
| 5 | | HW49 | 0.5 | | | | | | T/In | |
| 5 | | HW17 | 800 | | | | | | T/C | |

3.2.5

| | | | |
|--|--|-----------------|------------------------|
| | | | |
| | | HCl | 4.477 |
| | | | 8.316 |
| | | | 1.164 |
| | | SO ₂ | 5.29 |
| | | NO _x | 6.038 |
| | | | 16.834 |
| | | | 1.68 |
| | | HCl | 0.402 |
| | | NH ₃ | 0.027 |
| | | | 0 480m ³ /d |
| | | | 0 8m ³ /d |
| | | | 0 1273 |
| | | | 0 72000 |
| | | | 0 18.25 |

3.3

4

4.1

4.1.1

4.1.2

| CQ | 106.96 | 77.2 | / |
|------|--------|-------|------------------------------|
| DQ | 19.86 | 15.0 | / |
| DDQ | 15.28 | 12.0 | / |
| HSLA | 10.70 | 16.0 | 340 |
| DP | / | 5.0 | 590 TS 780 |
| | / | 27.0 | 50W1300/50W800/50W600/50W470 |
| | 152.8 | 152.8 | / |

| | | | |
|------------|------------|----------|------------|
| | | | |
| 0.3~2.5mm | 900~1575mm | 610mm | Max.1900mm |
| | | | |
| Max.28.35t | CQ HSLA | DQ DP | DDQ |

| | | | | | |
|--|----------|----------|--------|-------|--|
| | | | | | |
| | 1600000t | 1528000t | 72000t | 95.5% | |

4.1.3

| | | | | | |
|--|------|--------------------|--------------------|-----------------------|--|
| | | | | | |
| | | | | | |
| | 1720 | 7530m ² | 1 | 1720 | - |
| | | | | 152.8 | t |
| | | | | | 1720 |
| | | | | | 1# 2# 3# |
| | | | 1800m ² | 1 | |
| | | | | 18m ³ /min | / |
| | | 1720 | | | / |
| | | | | 8.5m ³ /h | / |
| | | | | 1200m ² | / |
| | | | 5400m ² | | / |
| | | | 3900m ² | | / |
| | | | 200m ² | | / |
| | | | | 3000m ³ | / |
| | | | | 25m ³ /h | / |
| | | | 301 | 1560m ³ /h | 273m ³ /h 1833m ³ /h |
| | | | | 20m ³ /h | / |

| | | | |
|--|---|------------------------|--|
| | | 8m ³ /d | |
| | 2 | 7800 kWh | 1500 kWh 9300 kWh |
| | | 6.5t/h 80 | / |
| | | 6450m ³ /h | 660m ³ /h 7110m ³ /h |
| | | 1200m ³ /h | / |
| | | + +30m | / |
| | | + +27m | / |
| | | + + +40m + +12m 1 1 | / |
| | | + + | |
| | | | + +25m |
| | | 301 | / |
| | | | |
| | | | / |

4.1.4

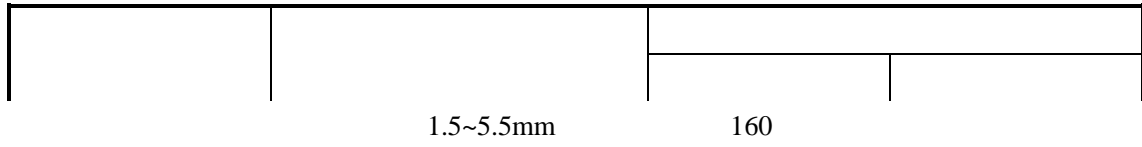

| | | | | | |
|--|--|--|--|--|--|
| | | | | | |
|--|--|--|--|--|--|

4.1.5

| | | | | | | |
|-------|-----------------|---|--|---|---|--------|
| | | | | | | |
| | | | | | | |
| 1# 2# | 39m 4×28t | 2 | | 39m 4×28t | 2 | |
| 3# | 4 | 1 | | 4 | 1 | |
| | 122m 1.45m | 1 | | 122m 1.45m | 1 | 6 IBOX |
| | 1#-4# UCM | 1 | | 1#-2# UCMW 3# HYPER UC-MILL 4# UCM | 1 | 1#~3# |
| | NMW-C | 1 | | C | 1 | |
| | | 1 | | | 1 | |
| | | | | / | 1 | |
| | | | | | 1 | |
| | | | | / | 2 | |
| | | | | 6mm | 1 | |
| | | | | | 1 | |
| | | | | / | 1 | |
| | | | | / | 2 | |
| | | | | 5m ³ | 4 | |
| | | | | 40m ³ | 1 | |
| | | 6 | | | 6 | |
| | R340mm | 1 | | R340mm | 1 | |
| 1# | | 1 | | | 1 | |
| | 5m 2.3m 1.6m | 1 | | 5m 2.3m 1.6m | 1 | |
| | / | 1 | | / | 1 | |
| | | 1 | | 188mm | 1 | |
| | / | 1 | | / | 1 | |
| | / | 1 | | / | 1 | |
| 1# 2# | / | 2 | | / | 2 | |
| | / | 2 | | / | 2 | |
| | / | 2 | | / | 2 | |
| | / | 2 | | / | 2 | |
| | / | 2 | | / | 2 | |

| | | | | | | |
|--|-----|---|--|-----|---|--|
| | 1m | 1 | | 1m | 1 | |
| | / | 2 | | / | 2 | |
| | / | 1 | | / | 1 | |
| | / | 8 | | / | 8 | |
| | / | 1 | | / | 1 | |
| | 18m | 1 | | 18m | 1 | |
| | / | 1 | | / | 1 | |
| | / | 1 | | / | 1 | |
| | / | 1 | | / | 1 | |
| | / | 1 | | / | 1 | |
| | / | 2 | | / | 2 | |
| | / | 2 | | / | 2 | |
| | / | 1 | | / | 1 | |
| | / | 1 | | / | 1 | |
| | | 1 | | | 1 | |

4.1.6

4.1.7

4.2

4.2.1

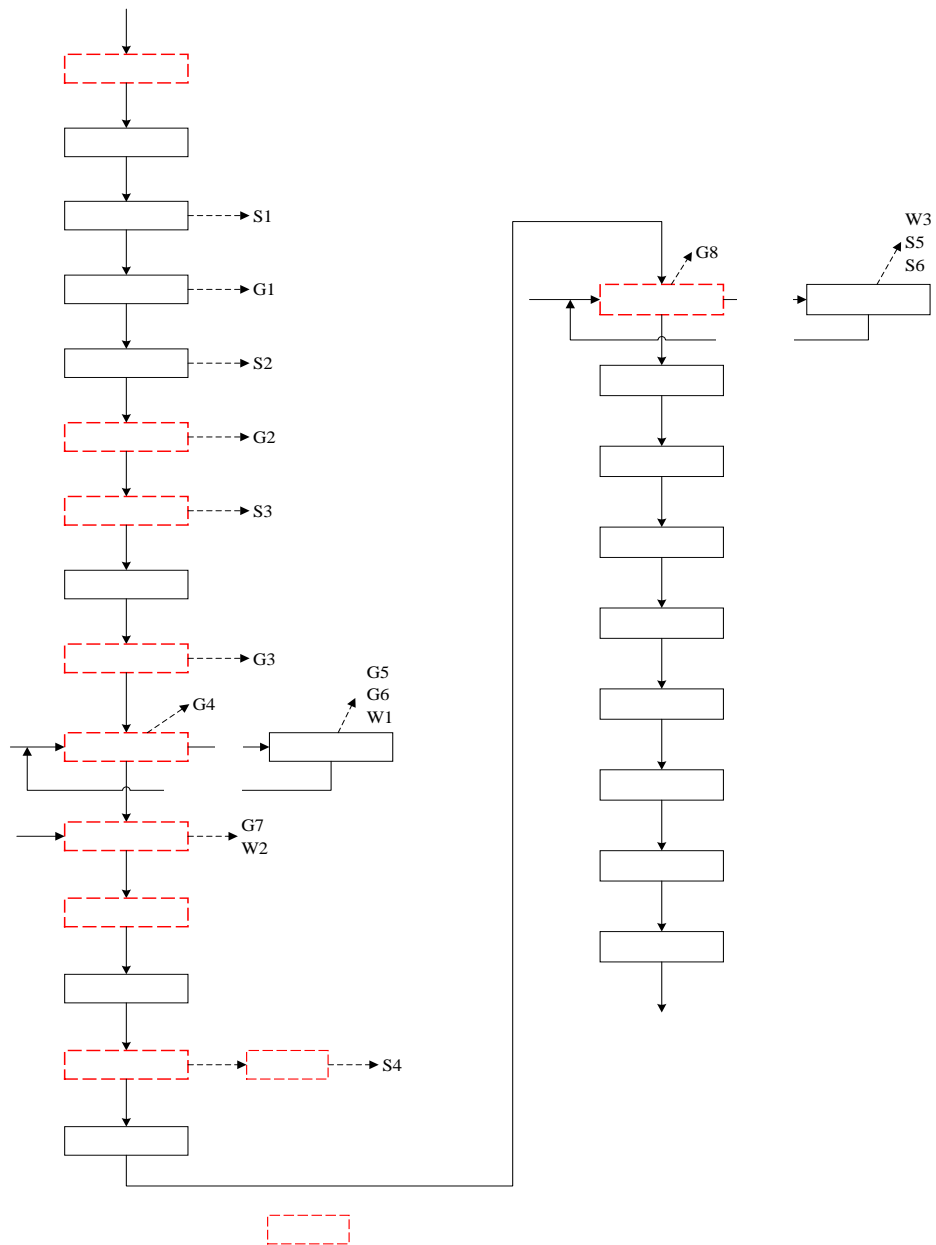



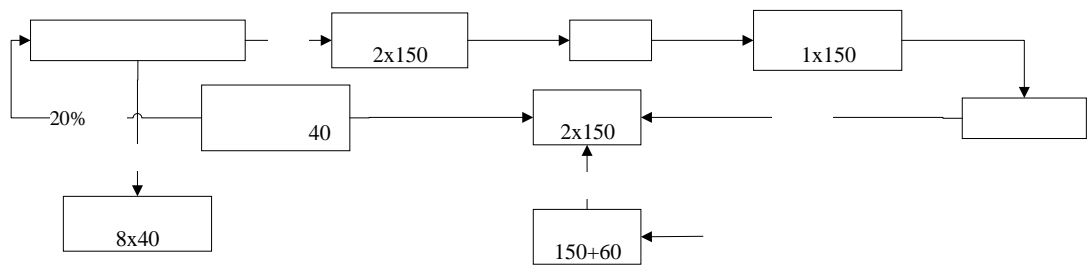





× ×



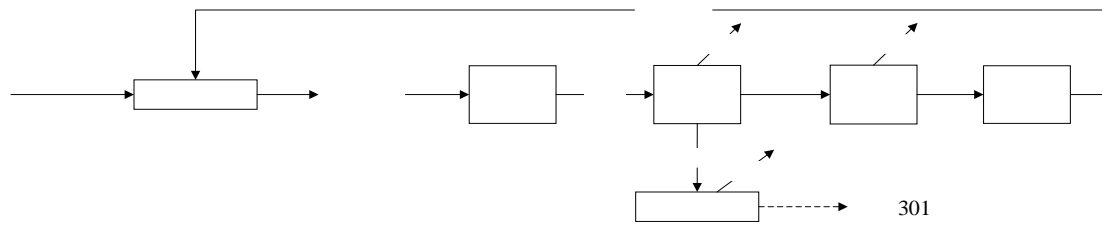



4.2.1.1

| | | | | |
|----------------|--------------------------------|----------------|--|-------------------------------------|
| | | | | |
| | G ₁ | | | |
| | G ₂ | | | |
| | G ₃ | | | |
| | G ₄ G ₇ | | | HCl |
| | G ₅ | | | HCl SO ₂ NO _x |
| | G ₆ | | | |
| | G ₈ | | | |
| | | W ₁ | | |
| W ₂ | | | | |
| W ₃ | | | | COD |
| | S ₁ ~S ₄ | | | |
| | S ₅ | | | |
| | S ₆ | | | |

4.2.2

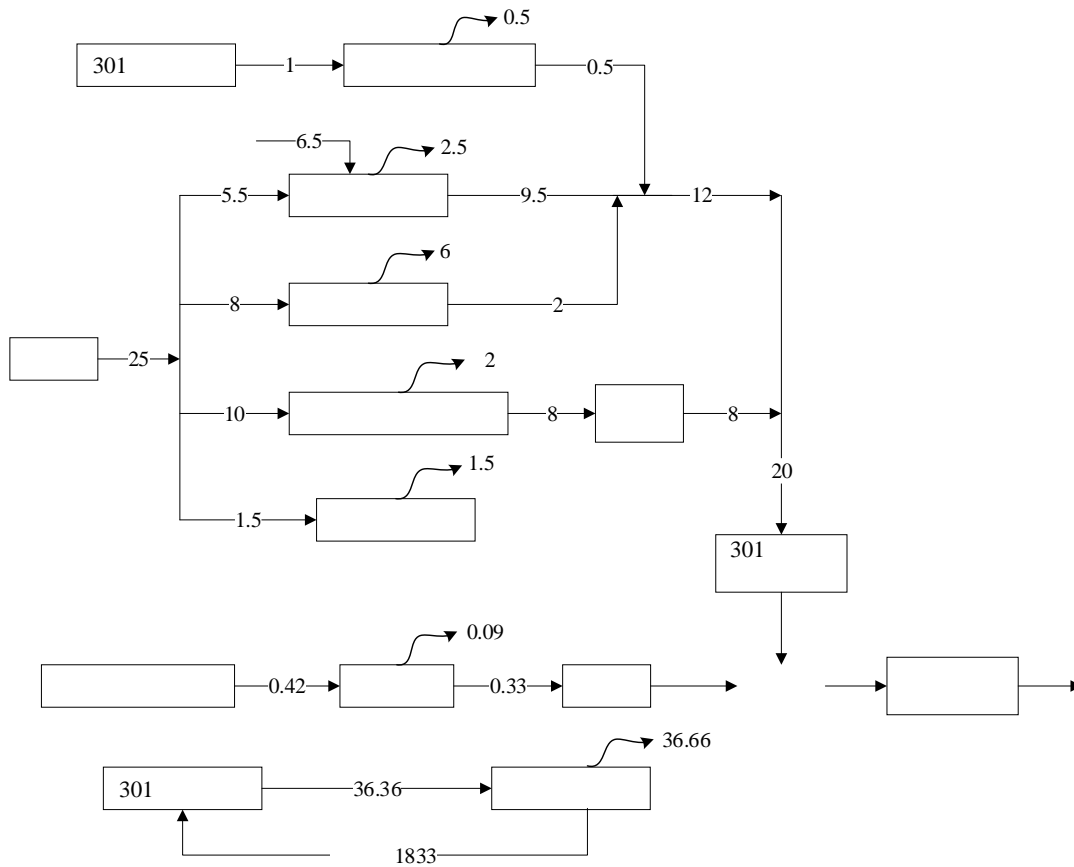

4.3

4.3.1

4.3.1.1

1

| | | | | | | | | | | | |
|--|----|--|--------|--------|-------|--|-----------|-----|-------|-------|---------|
| | | | | | | | | | | | |
| | | | | | | | | | | | |
| | 10 | | 203.07 | 20.307 | 158.4 | | 99.6 % | 0.8 | 0.081 | 0.634 | 25 m |

4.3.1.2

| | | | |
|----|--|-----------------|-------|
| | | | |
| 1# | | HCl | 1.412 |
| 2# | | | 8.316 |
| 3# | | HCl | 3.065 |
| | | | 0.556 |
| | | SO ₂ | 5.29 |
| | | NO _x | 6.038 |
| 4# | | | 0.608 |
| 5# | | | 0.634 |

| | | | |
|---|--|-----------------|-------|
| | | | |
| 1 | | | 0.02 |
| 2 | | | 0.24 |
| 3 | | | 0.75 |
| 4 | | | 1.68 |
| 5 | | HCl | 0.402 |
| 6 | | NH ₃ | 0.027 |

4.3.2

| | | | | | |
|--|--|--------------------|----------------------|--------|-----|
| | | | | | |
| | | | | | |
| | | | 288m ³ /d | | 301 |
| | | pH | 2~4 | | |
| | | COD | 1500 | 0.432 | |
| | | SS | 800 | 0.230 | |
| | | | 2000 | 0.576 | |
| | | | 192m ³ /d | | |
| | | COD | 8000 | 1.536 | |
| | | SS | 3000 | 0.576 | |
| | | | 15000 | 2.88 | |
| | | | 8m ³ /d | | |
| | | COD | 350 | 0.003 | |
| | | NH ₃ -N | 25 | 0.0002 | |
| | | SS | 250 | 0.002 | |

4.3.3

4.3.4

| | | | | | |
|---|---|--|-------|--|--|
| 1 | | | 62000 | | |
| 2 | | | 10000 | | |
| 3 | / | | 18.25 | | |
| 4 | | | 320 | | |
| 5 | | | 150 | | |
| 6 | | | 2.5 | | |
| 7 | | | 25 | | |
| 8 | | | 0.5 | | |
| 9 | | | 800 | | |

4.3.5

4.3.5.1

| | | | | |
|--|--|-------|---------|-------|
| | | | | |
| | | 158.4 | 157.766 | 0.634 |

4.3.5.2

| | | | | |
|--|--|--------------------|-------|-----|
| | | | | |
| | | HCl | 1.412 | |
| | | | 8.316 | |
| | | HCl | 3.065 | |
| | | | 0.556 | |
| | | SO ₂ | 5.29 | |
| | | NO _x | 6.038 | |
| | | | 0.608 | |
| | | | 0.634 | |
| | | | 0.24 | " " |
| | | | 0.02 | |
| | | | 1.68 | |
| | | | 0.75 | |
| | | HCl | 0.402 | |
| | | NH ₃ | 0.027 | |
| | | COD | 0 | |
| | | NH ₃ -N | 0 | |
| | | | 0 | |
| | | | 0 | |

4.3.5.3 "

| | | | | | |
|--|--|--|--------|------|---------------|
| | | | | | " " |
| | | | 16 | 0.24 | 15.76 |
| | | | 0.084 | 0.02 | 0.064 |
| | | | 16.084 | 0.26 | 15.824 |

4.3.6

" "

4.3-9

t/a

| | | | | | | |
|--|-----------------|------------------------|-------|--------|-------|---------|
| | | | | | | |
| | HCl | 4.477 | 0 | 0 | 4.477 | 0 |
| | | 8.316 | 0 | 0 | 8.316 | 0 |
| | | 1.164 | 0.634 | 0 | 1.798 | +0.634 |
| | SO ₂ | 5.29 | 0 | 0 | 5.29 | 0 |
| | NO _x | 6.038 | 0 | 0 | 6.038 | 0 |
| | | 16.834 | 0 | 15.824 | 1.01 | -15.824 |
| | | 1.68 | 0 | 0 | 1.68 | 0 |
| | HCl | 0.402 | 0 | 0 | 0.402 | 0 |
| | NH ₃ | 0.027 | 0 | 0 | 0.027 | 0 |
| | | 0 8m ³ /d | 0 | 0 | 0 | 0 |
| | | 0 480m ³ /d | 0 | 0 | 0 | 0 |
| | | 0 72000 | 0 | 0 | 0 | 0 |
| | | 0 1273 | 0 | 0 | 0 | 0 |
| | | 0 18.25 | 0 | 0 | 0 | 0 |

4.4

4.4.1

4.4.2

4.4.3

4.4.4

5

5.1

5.1.1

-
-

-
-

5.1.2

10m

150-250m

458.9m

120m

15-60m

5.1.4

5.1.5

5.1.7

5.2

5.2.1

| | | | |
|---|--|---|-------------|
| | | | |
| 1 | | | GB3095-2012 |
| 2 | | | GB3838-2002 |
| 3 | | 3 | GB3096-2008 |

5.2.2

5.3

5.3.1

5.3.1.1

| | | | | | | |
|------|----|------|----|-------------------|------------------|------|
| 2018 | | AQI | 27 | 265 | | |
| 57 | | 200 | | | 71.4% | |
| | | 5.8 | | PM _{2.5} | 45 | |
| / | | | | 10.0% | PM ₁₀ | |
| 75 | / | | | | 9.6% | |
| 15 | / | | | | 11.8% | |
| | 37 | / | | | 5.1% | |
| 95 | | 1.7 | / | | | |
| 5.6% | 8 | | 90 | 183 | / | |
| | | 2.7% | | 3.90% | pH | 6.11 |

| | | | | | |
|-------------------|---------------------------|------|------|------|--|
| | | | | | |
| SO ₂ | | 15 | 60 | 0 | |
| NO ₂ | | 37 | 40 | 0 | |
| PM ₁₀ | | 75 | 70 | 0.07 | |
| PM _{2.5} | | 45 | 35 | 0.29 | |
| CO | 95 | 1700 | 4000 | 0 | |
| O ₃ | 8 90 | 183 | 160 | 0.14 | |

5.3.1.2

| G1 | SO ₂ | 7 | 15 | 0 | 0.03 | 9 | 13 | 0 | 0.09 |
|----|-------------------|----|----|---|------|-----|-----|---|------|
| | NO ₂ | 14 | 35 | 0 | 0.18 | 23 | 26 | 0 | 0.33 |
| | PM _{2.5} | / | / | / | / | 48 | 60 | 0 | 0.80 |
| | PM ₁₀ | / | / | / | / | 81 | 89 | 0 | 0.59 |
| | TSP | / | / | / | / | 118 | 124 | 0 | 0.41 |
| | HCl | 20 | 20 | 0 | 0.40 | / | / | / | / |
| | NH ₃ | 10 | 30 | 0 | 0.15 | / | / | / | / |
| G2 | SO ₂ | 8 | 20 | 0 | 0.04 | 12 | 15 | 0 | 0.10 |
| | NO ₂ | 15 | 37 | | 0.19 | 24 | 28 | 0 | 0.35 |
| | PM _{2.5} | / | / | / | / | 47 | 60 | 0 | 0.80 |
| | PM ₁₀ | / | / | / | / | 80 | 90 | 0 | 0.60 |
| | TSP | / | / | / | / | 117 | 124 | 0 | 0.41 |
| | HCl | 20 | 20 | 0 | 0.40 | / | / | / | / |
| | NH ₃ | 30 | 60 | 0 | 0.30 | / | / | / | / |

5.3.2

| | | | | |
|----|--|-------|--|------------------------------------|
| | | | | |
| W1 | | 500m | | pH COD NH ₃ -N SS TP |
| W2 | | 1000m | | |
| W3 | | 2500m | | |

$$S_{\text{pH}_j} = \frac{7.0 - \text{pH}_j}{7.0 - \text{pH}_{\text{sd}}} \quad \text{pH}_j \leq 7.0$$

$$S_{\text{pH}_j} = \frac{\text{pH}_j - 7.0}{\text{pH}_{\text{su}} - 7.0} \quad \text{pH}_j > 7.0$$

| | | | | | | | | |
|----|-----|------|-------|------|-------|-------|------|-------|
| | | | | | | | | |
| W1 | | 7.15 | 10 | 0.47 | 13 | 0.04 | 0.02 | 22.1 |
| | | 7.26 | 12 | 0.49 | 14 | 0.05 | 0.04 | 23.7 |
| | | 7.21 | 11.00 | 0.48 | 13.50 | 0.045 | 0.03 | 22.90 |
| | | 0.10 | 0.55 | 0.48 | 0.45 | 0.225 | 0.6 | / |
| | (%) | 0 | 0 | 0 | 0 | 0 | 0 | / |
| W2 | | 7.19 | 15 | 0.53 | 16 | 0.07 | 0.02 | 24.2 |
| | | 7.24 | 16 | 0.56 | 18 | 0.08 | 0.04 | 25.1 |
| | | 7.22 | 15.50 | 0.55 | 17.00 | 0.075 | 0.03 | 24.65 |
| | | 0.11 | 0.78 | 0.55 | 0.57 | 0.38 | 0.60 | / |
| | (%) | 0 | 0 | 0 | 0 | 0 | 0 | / |
| W3 | | 7.20 | 12 | 0.50 | 14 | 0.05 | 0.02 | 22.3 |
| | | 7.24 | 14 | 0.52 | 16 | 0.08 | 0.03 | 23.4 |
| | | 7.22 | 13.00 | 0.51 | 15.00 | 0.07 | 0.03 | 22.85 |
| | | 0.11 | 0.65 | 0.51 | 0.50 | 0.33 | 0.50 | / |
| | (%) | 0 | 0 | 0 | 0 | 0 | 0 | / |

5.3.3



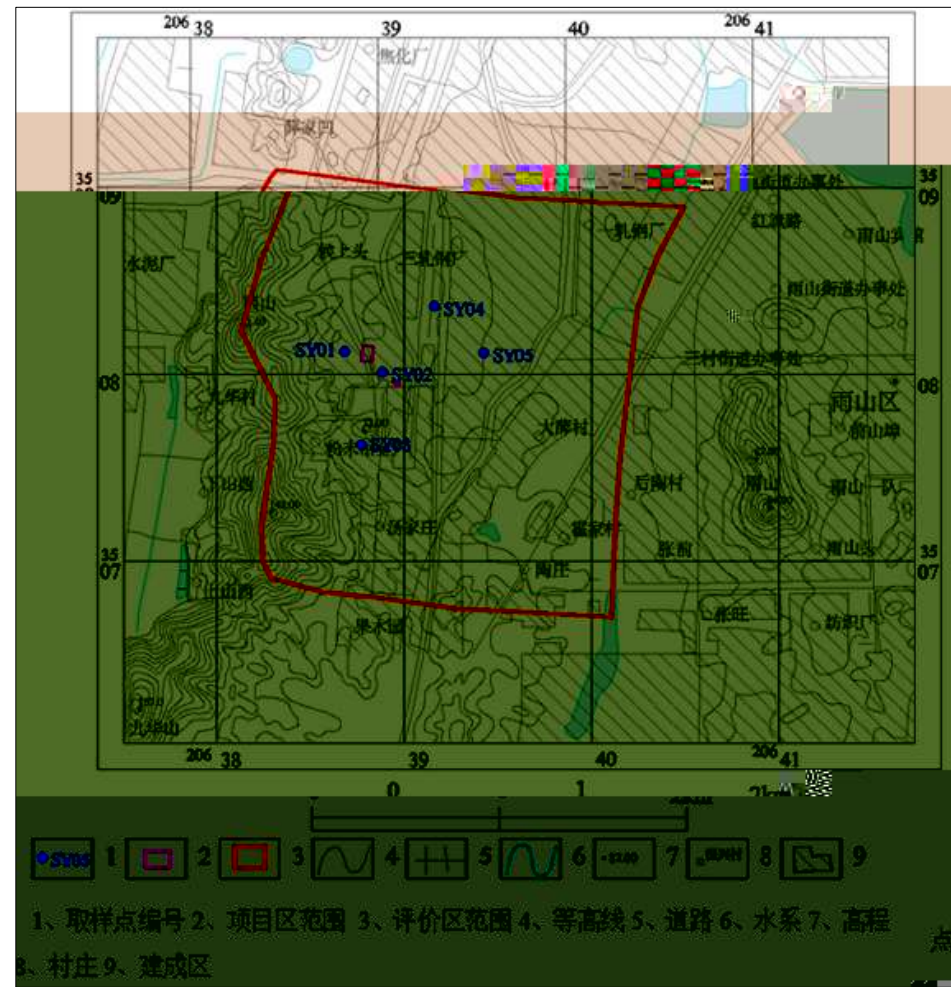
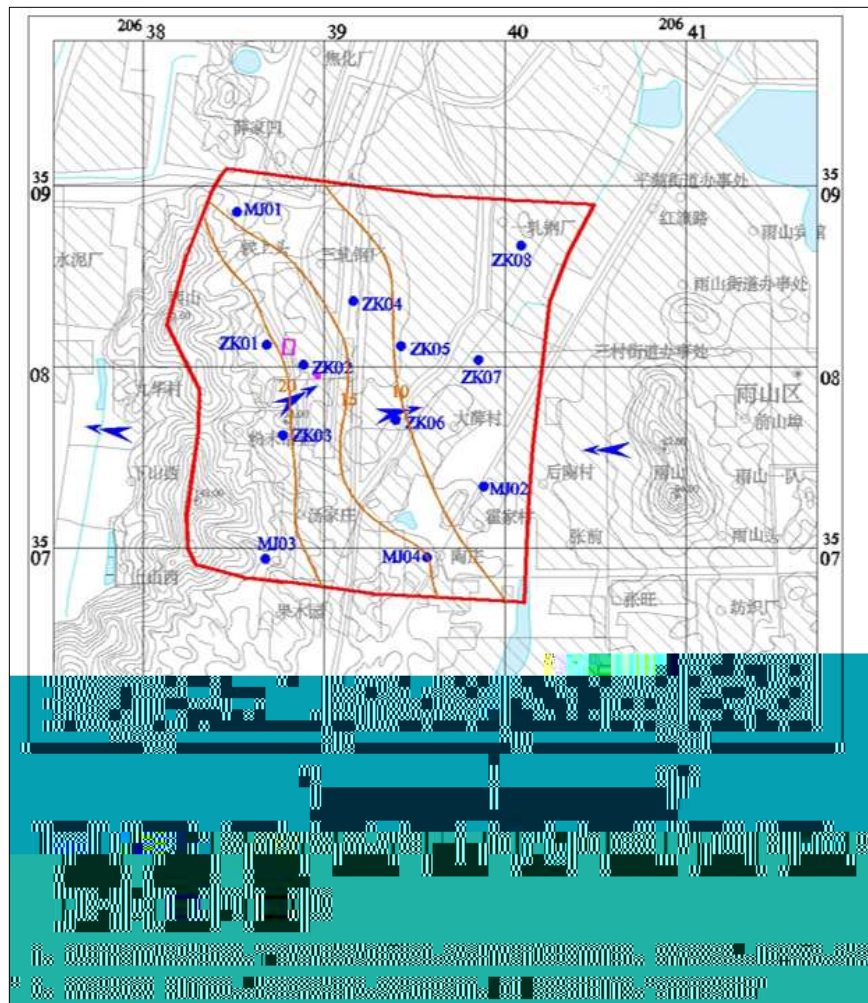

| | | | | |
|------|--|---|----|--|
| | | | | |
| SY01 | | | 10 | |
| SY02 | | - | 10 | |
| SY03 | | | 10 | |
| SY04 | | | 10 | |
| SY05 | | | 10 | |

| | | | | | | | |
|------|-------------|------------|------|------|--|-----|------|
| | | | | | | | |
| | | | | | | | |
| MJ01 | 20638467.11 | 3508987.12 | 12.5 | 5 | | 1.1 | 11.4 |
| MJ02 | 20639831.76 | 3507356.43 | 9.8 | 6 | | 1.5 | 8.3 |
| MJ03 | 20638677.16 | 3506965.45 | 24.6 | 8.0 | | 2.8 | 21.8 |
| MJ04 | 20639518.78 | 3506961.95 | 16.6 | 8.0 | | 1.5 | 15.1 |
| ZK01 | 20638626.95 | 3508124.13 | 22.6 | 10.0 | | 2 | 20.6 |
| ZK02 | 20638833.60 | 3508025.07 | 18.9 | 10.0 | | 2 | 16.9 |
| ZK03 | 20638713.82 | 3507580.02 | 22.5 | 10.0 | | 1.8 | 20.7 |
| ZK04 | 20639113.83 | 3508369.05 | 15.8 | 10.0 | | 1.6 | 14.2 |
| ZK05 | 20639368.57 | 3508122.29 | 10.5 | 10.0 | | 1.3 | 9.2 |
| ZK06 | 20639345.39 | 3507717.21 | 11.5 | 10.0 | | 1.2 | 10.3 |
| ZK07 | 20639805.30 | 3508053.08 | 8.9 | 10.0 | | 1.3 | 7.6 |
| ZK08 | 20640039.97 | 3508682.16 | 8.0 | 10.0 | | 1.2 | 6.8 |

| | | | | | | | |
|--|--|--|--|--|--|--|--|
| | | | | | | | |
| | | | | | | | |
| | | | | | | | |
| | | | | | | | |
| | | | | | | | |
| | | | | | | | |
| | | | | | | | |

| | | | | | | | | | | | | | | | | | | | |
|------|---------|--------|-------|-------|-------|-------|-------|------|---------|--------|---------|---------|---------|---------|------|--------|------|-------|--|
| | | | | | | | | | | | | | | | | | | | |
| SY01 | 7.36 | 281.36 | 36.12 | 0.046 | 4.14 | 0.18 | 56.39 | 0.21 | 0.00089 | <0.004 | 0.00082 | <0.0001 | 0.00215 | 0.00652 | 2.61 | <0.002 | 471 | 0.045 | |
| SY02 | 7.50 | 287.23 | 72.08 | 0.05 | 0.946 | <0.04 | 82.63 | 0.21 | <0.0005 | <0.004 | 0.00053 | <0.0001 | 0.00315 | 0.00122 | 1.70 | <0.002 | 516 | 0.038 | |
| SY03 | 7.49 | 127.41 | 54.07 | 0.032 | 0.402 | 0.19 | 38.87 | 0.34 | <0.0005 | 0.0073 | 0.00050 | <0.0001 | 0.00841 | 0.0032 | 2.56 | <0.002 | 255 | 0.04 | |
| SY04 | 7.45 | 153.14 | 55.06 | 0.004 | 0.395 | 0.15 | 42.19 | 0.32 | <0.0005 | 0.0063 | 0.00030 | <0.0001 | 0.00072 | 0.0028 | 2.21 | <0.002 | 270 | 0.018 | |
| SY05 | 7.48 | 139.03 | 50.06 | 0.004 | 0.361 | 0.15 | 40.19 | 0.32 | <0.0005 | <0.004 | 0.00078 | <0.0001 | 0.0012 | 0.0035 | 1.84 | <0.002 | 250 | 0.025 | |
| | 6.5~8.5 | | | | | | | | | | | | 0.01 | 0.01 | 3.0 | | 1000 | 0.05 | |

| | | | | | | | | | | | | | | | | | | | |
|------|------|--|--|--|--|--|--|--|--|--|--|--|--|--|--|--|--|--|--|
| | | | | | | | | | | | | | | | | | | | |
| | | | | | | | | | | | | | | | | | | | |
| SY01 | 0.24 | | | | | | | | | | | | | | | | | | |
| SY02 | 0.33 | | | | | | | | | | | | | | | | | | |
| SY03 | 0.33 | | | | | | | | | | | | | | | | | | |
| SY04 | 0.30 | | | | | | | | | | | | | | | | | | |
| SY05 | 0.32 | | | | | | | | | | | | | | | | | | |

5.3.4

A

| | | | | | |
|----|--|------|------|----|--|
| | | | | | |
| N1 | | 55.2 | 54.5 | 65 | |
| N2 | | 54.1 | 53.8 | | |
| N3 | | 54.6 | 54.0 | | |
| N4 | | 55.0 | 54.2 | | |
| N5 | | 55.5 | 54.7 | | |
| N1 | | 45.3 | 44.4 | 55 | |
| N2 | | 44.5 | 44.0 | | |
| N3 | | 44.7 | 44.1 | | |
| N4 | | 45.1 | 44.3 | | |
| N5 | | 45.6 | 44.6 | | |

GB3096-2008

3

5.3.5

| | | | | |
|----------|--------|--------|--------|------|
| | | | | |
| pH | 6.84 | 6.90 | 6.88 | / |
| | 89 | 84 | 79 | 4500 |
| mg/kg | | | | |
| | 18.2 | 18.5 | 17.6 | 60 |
| | 0.19 | 0.16 | 0.14 | 65 |
| | 3.96 | 3.58 | 3.88 | 5.7 |
| | 36 | 33 | 37 | 2000 |
| | 34.8 | 33.2 | 35.7 | 400 |
| | 0.0300 | 0.0384 | 0.0327 | 38 |
| | 46 | 38 | 43 | 900 |
| | <1.3 | <1.3 | <1.3 | 2.8 |
| | <1.1 | <1.1 | <1.1 | 0.9 |
| | <1.0 | <1.0 | <1.0 | 37 |
| 1,1- | <1.2 | <1.2 | <1.2 | 9 |
| 1,2- | <1.3 | <1.3 | <1.3 | 5 |
| 1,1- | <1.2 | <1.2 | <1.2 | 66 |
| -1,2- | <1.3 | <1.3 | <1.3 | 596 |
| -1,2- | <1.4 | <1.4 | <1.4 | 54 |
| | <1.5 | <1.5 | <1.5 | 616 |
| 1,2 | <1.1 | <1.1 | <1.1 | 5 |
| 1,1,1,2- | <1.2 | <1.2 | <1.2 | 10 |
| 1,1,2,2- | <1.2 | <1.2 | <1.2 | 6.8 |
| | <1.4 | <1.4 | <1.4 | 53 |
| 1,1,1- | <1.3 | <1.3 | <1.3 | 840 |
| 1,1,2- | <1.2 | <1.2 | <1.2 | 2.8 |
| | <1.2 | <1.2 | <1.2 | 2.8 |

| | | | | |
|--------|-------|-------|-------|------|
| 1,2,3- | <1.2 | <1.2 | <1.2 | 0.5 |
| | <1.0 | <1.0 | <1.0 | 0.43 |
| | <1.9 | <1.9 | <1.9 | 4 |
| | <1.2 | <1.2 | <1.2 | 270 |
| 1,2- | <1.5 | <1.5 | <1.5 | 560 |
| 1,4- | <1.5 | <1.5 | <1.5 | 20 |
| | <1.2 | <1.2 | <1.2 | 28 |
| | <1.1 | <1.1 | <1.1 | 1290 |
| | <1.3 | <1.3 | <1.3 | 1200 |
| + | <1.2 | <1.2 | <1.2 | 570 |
| | <1.2 | <1.2 | <1.2 | 640 |
| mg/kg | | | | |
| | <0.09 | <0.09 | <0.09 | 76 |
| | <0.06 | <0.06 | <0.06 | 260 |
| 2- | <1.2 | <1.2 | <1.2 | 2256 |
| [a] | <0.1 | <0.1 | <0.1 | 15 |
| [a] | <0.1 | <0.1 | <0.1 | 1.5 |
| [b] | <0.2 | <0.2 | <0.2 | 15 |
| [k] | <0.1 | <0.1 | <0.1 | 151 |
| | <0.1 | | | |

| | | | |
|-------------|----|----|----|
| -1,2- | ND | ND | ND |
| | ND | ND | ND |
| 1,2 | ND | ND | ND |
| 1,1,1,2- | ND | ND | ND |
| 1,1,2,2- | ND | ND | ND |
| | ND | ND | ND |
| 1,1,1- | ND | ND | ND |
| 1,1,2- | ND | ND | ND |
| | ND | ND | ND |
| 1,2,3- | ND | ND | ND |
| | ND | ND | ND |
| | ND | ND | ND |
| | ND | ND | ND |
| 1,2- | ND | ND | ND |
| 1,4- | ND | ND | ND |
| | ND | ND | ND |
| | ND | ND | ND |
| | ND | ND | ND |
| + | ND | ND | ND |
| | ND | ND | ND |
| | ND | ND | ND |
| | ND | ND | ND |
| 2- | ND | ND | ND |
| [a] | ND | ND | ND |
| [a] | ND | ND | ND |
| [b] | ND | ND | ND |
| [k] | ND | ND | ND |
| | ND | ND | ND |
| [a h] | ND | ND | ND |
| [1 2 3-c d] | ND | ND | ND |
| | ND | ND | ND |

6

6.1

6.2

6.2.1

6.2.1.1

| | | | |
|-----|--------|------------|-------|
| | | | |
| | 16.9 | | |
| | 38.1 | 2013-08-11 | 42.0 |
| | -6.1 | 2016-01-24 | -10.3 |
| hPa | 1011.6 | | |
| hPa | 15.8 | | |
| % | 72.5 | | |
| mm | 1148.8 | | |



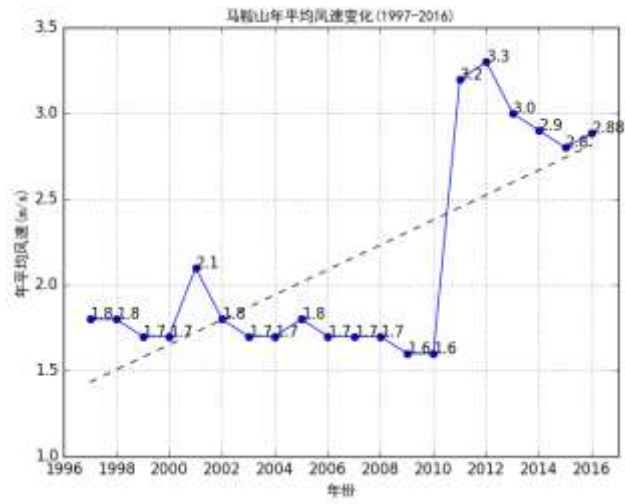

6.2.2

| | | | | | | | | | |
|--|--------|---------|----|----|-----|------|----|------|-------|
| | | | | | | | | | |
| | | | | | | | | | |
| | 639118 | 3506426 | 18 | 25 | 1.5 | 17.2 | 25 | 7800 | 0.081 |

| | | | | | | | | | |
|--|--------|---------|----|----|-----|------|----|------|--------|
| | | | | | | | | | |
| | | | | | | | | | |
| | 639118 | 3506426 | 18 | 25 | 1.5 | 17.2 | 25 | 7800 | 20.307 |

| | | | | | | | | | |
|------|--------|---------|----|-----|----|----|------|--|------|
| | | | | | | | | | |
| | | | | | | | | | |
| 1720 | 639066 | 3506292 | 18 | 320 | 30 | 20 | 8760 | | 0.03 |

6.2.3

6.2.3.1

6.2.3.2

6.2.3.3

| | | |
|---|----|-------|
| | | |
| / | / | |
| | | 229.3 |
| | / | 42.0 |
| | / | -10.3 |
| | | |
| | | |
| | /m | 90 |
| | | |

6.2.3.4

| | | | | | | |
|------|--|------------------|-----|--------|--------|---|
| | | | | | | |
| | | PM ₁₀ | 450 | 4.0834 | 0.9074 | / |
| 1720 | | TSP | 900 | 3.3162 | 0.3685 | / |

1%

HJ2.2-2018

6.2.4

6.2.4.1

| | | | | | |
|---|----|--|-----|-------|-------|
| | | | | | |
| 1 | 1# | | 0.8 | 0.081 | 0.634 |

| | | |
|---|--|-------|
| | | |
| 1 | | 0.634 |

| | | | | | | | | |
|----|--|--|--|--------|--------|----|---|--|
| | | | | | | | | |
| 1# | | | | 101.54 | 10.154 | 1h | 2 | |

6.2.5

6.2.6

6.2.7

6.2.8

| | | | | | |
|--|----------------------------------|-------------------------|--------|--|--|
| | | | | | |
| | | | 5 | =5 km | |
| | SO ₂ +NO _x | | 500 ~ | 500 t/a | |
| | | HCl NH ₃ TSP | | PM _{2.5} PM _{2.5} | |
| | | | | D | |
| | | | | | |
| | | | 2018 | | |
| | | | | | |
| | | | | | |
| | | | 5 50km | | |
| | | | | PM _{2.5} PM _{2.5} | |
| | | C | | C | |
| | | C | | C | |
| | | C | | C | |
| | 1h | h | C | C | |
| | | C | | C | |
| | | k - | | k - | |
| | | | | | |

| | | | | |
|--|--|-----------------------|-------------|-----------|
| | | | | |
| | | | | |
| | | m | | |
| | | SO ₂ : t/a | : 0.634 t/a | VOCs: t/a |
| | | | | |

6.3

6.3.1

6.3.2

6.3.3

| | | | |
|--|--|----|----|
| | | | |
| | | | |
| | | | |
| | | | |
| | | pH | |
| | | | |
| | | A | B |
| | | | |
| | | | |
| | | | |
| | | | |
| | | | |
| | | | |
| | | | |
| | | | |
| | | | |
| | | km | km |
| | | | |

| | | | |
|--|--|-----|----|
| | | III | |
| | | | |
| | | | |
| | | km | km |
| | | | |
| | | | |
| | | | |
| | | | |

6.4

6.5

6.5.1

2016

| | | | | |
|---|--|------|-------|--|
| | | | | |
| 1 | | / | 62000 | |
| 2 | | / | 10000 | |
| 3 | | / | 18.25 | |
| 4 | | HW08 | 320 | |
| 5 | | HW49 | 150 | |
| 6 | | HW49 | 2.5 | |
| 7 | | HW08 | 25 | |
| 8 | | HW49 | 0.5 | |
| 9 | | HW17 | 800 | |

6.5.2

|

-

|

6.5.3

“ ”

6.6

6.6.1

6.6.1.1

• •



•

•

•

•

•

•

•

•

6.6.1.2

6.6.2

6.7

6.7.1

6.7.2

| | | | | | | | | |
|--|--|--|--|--|--|--|--|--|
| | | | | | | | | |
| | | | | | | | | |
| | | | | | | | | |
| | | | | | | | | |
| | | | | | | | | |
| | | | | | | | | |
| | | | | | | | | |
| | | | | | | | | |
| | | | | | | | | |
| | | | | | | | | |
| | | | | | | | | |
| | | | | | | | | |
| | | | | | | | | |
| | | | | | | | | |
| | | | | | | | | |
| | | | | | | | | |
| | | | | | | | | |
| | | | | | | | | |
| | | | | | | | | |
| | | | | | | | | |
| | | | | | | | | |

6.8

| | | | | | |
|--|--|--|--|--|------------------|
| | | | | | LC ₅₀ |
|--|--|--|--|--|------------------|

6.8.1.2

6.8.2

6.8.2.1

$$Q = \frac{q_1}{Q_1} + \frac{q_2}{Q_2} + \dots + \frac{q_n}{Q_n}$$

..... ---

..... ---

| | | | | | |
|---|---------|-----------|-----|------|-------|
| | | | | | |
| 1 | 25% | 1336-21-6 | 36 | 10 | 3.6 |
| 2 | | / | 15 | 2500 | 0.006 |
| 3 | 20%~32% | 7647-01-0 | 708 | / | / |
| | | | | | 3.606 |

| | | |
|---|-------|-----------|
| | | |
| | | 10/ |
| | | 5/ |
| | a | 5/ |
| / | / | 10 |
| | b | 10 |
| | | 5 |
| a | b 300 | P 10.0MPa |

| | | | | |
|----------|----|----|----|----|
| | | | | |
| | | | | |
| Q 100 | P1 | P1 | P2 | P3 |
| 10 Q 100 | P1 | P2 | P3 | P4 |
| 1 Q 10 | P2 | P3 | P4 | P4 |

6.8.2.2

| | | | | | |
|----|------------------|---|--------------|---------------------|-----|
| | | | | | |
| E1 | 5km 5 1000 | | | 500m 200m 200 | |
| E2 | 5km 1 1000 | 5 | | 500m 200m 100 | 500 |
| E3 | 5km 1 | | 500m 200m | 500 | 100 |

| | |
|----|-----|
| | |
| F1 | 24h |
| F2 | 24h |
| F3 | |

| | |
|----|------|
| | |
| S1 | 10km |
| S2 | 10km |

| | |
|----|-------------|
| | |
| S3 | 10km 1 2 |

| | | | |
|----|----|----|----|
| | | | |
| S1 | E1 | E1 | E2 |
| S2 | E1 | E2 | E3 |
| S3 | E1 | E2 | E3 |

| | |
|----|--|
| | |
| G1 | |
| G2 | |
| G3 | |

| | |
|----|---|
| | |
| D3 | $^{-6}\text{cm/s}$ |
| D2 | 1.0m $^{-6}\text{cm/s}$ $1 \times 10^{-6}\text{cm/s}$ $^{-4}\text{cm/s}$ |
| D1 | D2 D3 |

| | |
|----|--|
| | |
| G1 | |

| | |
|----|--|
| G2 | |
| G3 | |

| | | | |
|----|----|----|----|
| | | | |
| D1 | E1 | E1 | E2 |
| D2 | E1 | E2 | E3 |
| D3 | E2 | E3 | E3 |

6.8.2.3

| | | | | |
|----|-----|----|--|--|
| | | | | |
| E1 | IV+ | IV | | |
| E2 | IV | | | |
| E3 | | | | |

6.8.3 !

6.8.4

| | | | | | |
|--|--|--|--|--|--|
| | | | | | |
| | | | | | |
| | | | | | |
| | | | | | |
| | | | | | |
| | | | | | |
| | | | | | |

6.8.5

6.8.5.1

×

6.8.5.2

$$Q_L = C_d A \rho \sqrt{\frac{2(P - P_0)}{\rho} + 2gh}$$

6.8.6

| | | |
|----|-----|------------|
| | | |
| 1 | 90 | 2.4524E+01 |
| 3 | 120 | 2.4524E+01 |
| 5 | 120 | 2.6719E+01 |
| 7 | 120 | 2.6719E+01 |
| 9 | 120 | 2.6719E+01 |
| 11 | 120 | 2.6719E+01 |
| 13 | 120 | 2.6719E+01 |
| 15 | 120 | 2.6719E+01 |
| 17 | 120 | 2.6719E+01 |
| 19 | 120 | 2.6719E+01 |
| 21 | 120 | 2.6719E+01 |
| 23 | 120 | 2.6719E+01 |
| 25 | 120 | 2.6719E+01 |
| 27 | 120 | 2.6719E+01 |
| 29 | 120 | 2.6719E+01 |

| | | | | | |
|-----|--------|-----|-----|--|----|
| | | | | | |
| HCl | 26.719 | 120 | 150 | | 33 |

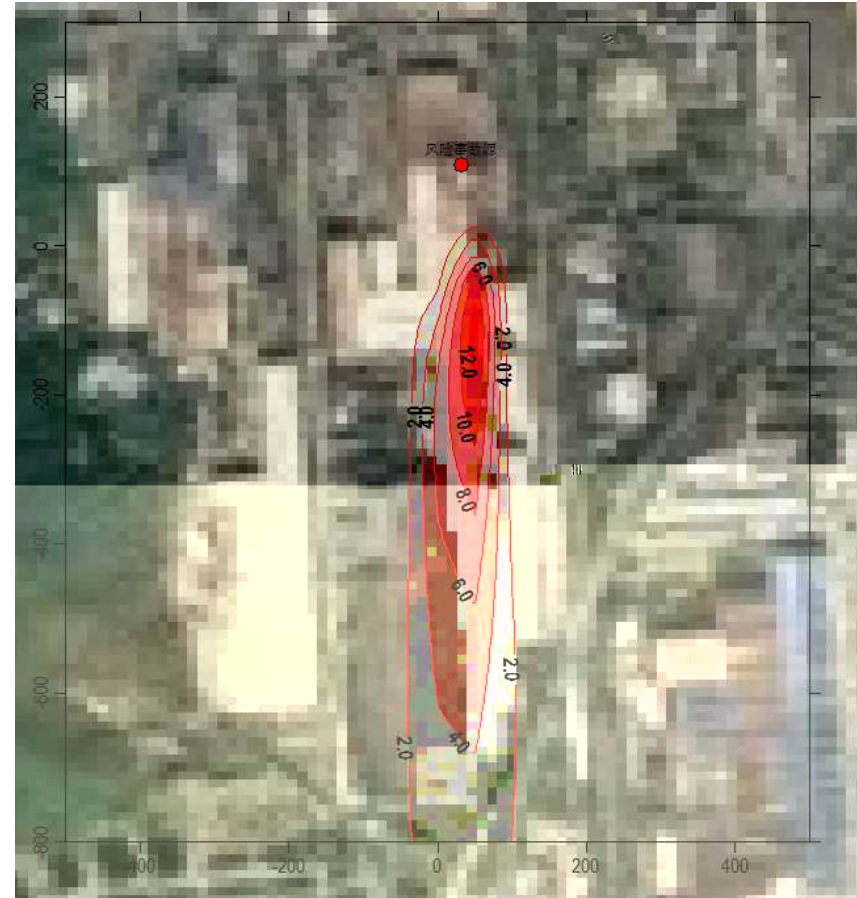
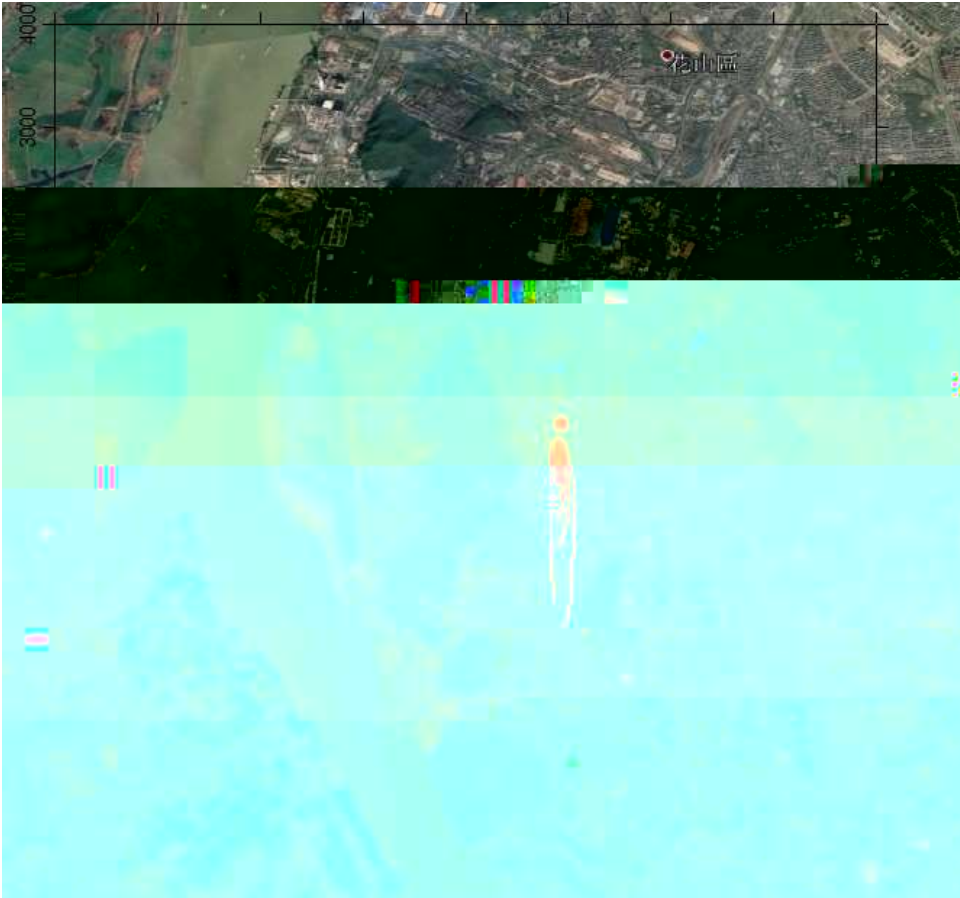

6.8.7

6.8.7.1

6.8.7.2

6.8.9

6.8.10

| | | | | | | | |
|--|--|--|-------|--|--|-------|--|
| | | | | | | | |
| | | | | | | | |
| | | | | | | | |
| | | | _____ | | | _____ | |
| | | | _____ | | | | |
| | | | | | | | |
| | | | | | | | |
| | | | | | | | |
| | | | | | | | |
| | | | | | | | |

7

7.1

7.1.1

7.1.1.1

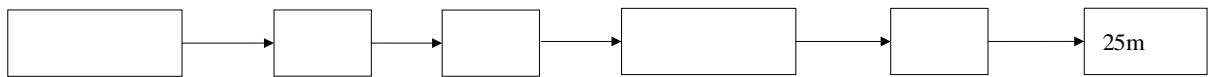

HJ-BAT-006

99.5%~99.9%

7.1.1.2

| | | | | |
|--|--|--|-----|-----|
| | | | | 25m |
| | HCl | | | 30m |
| | | | | 27m |
| | HCl SO ₂ NO _x | | + | 40m |
| | | | 1 1 | 12m |

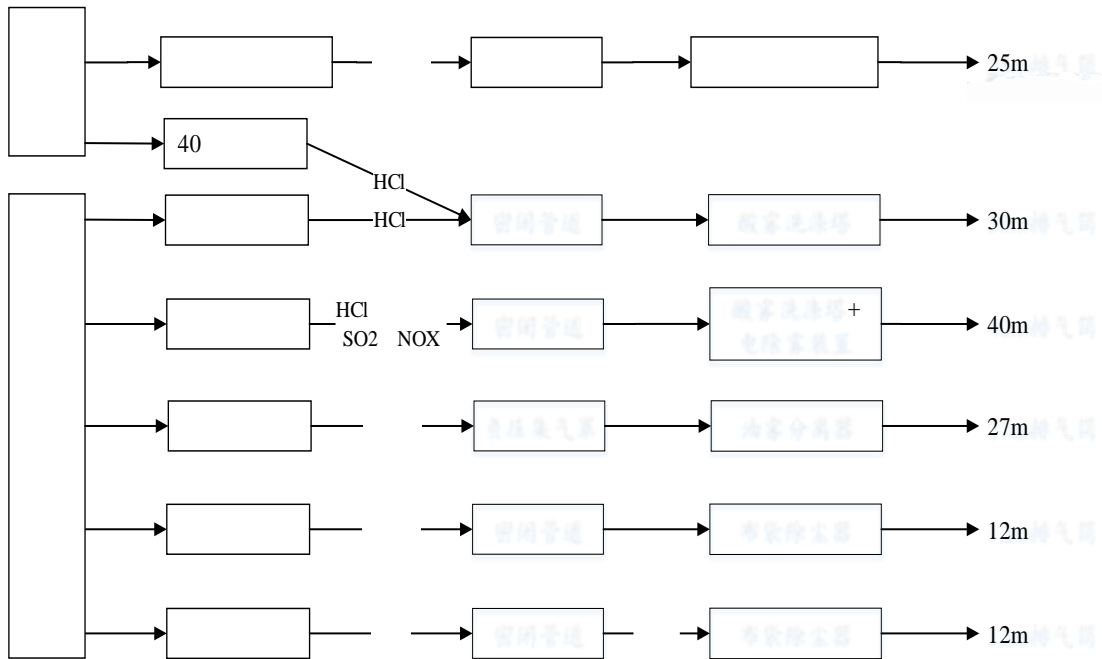

7.1.2

7.1.3

7.2

7.2.1

7.2.2

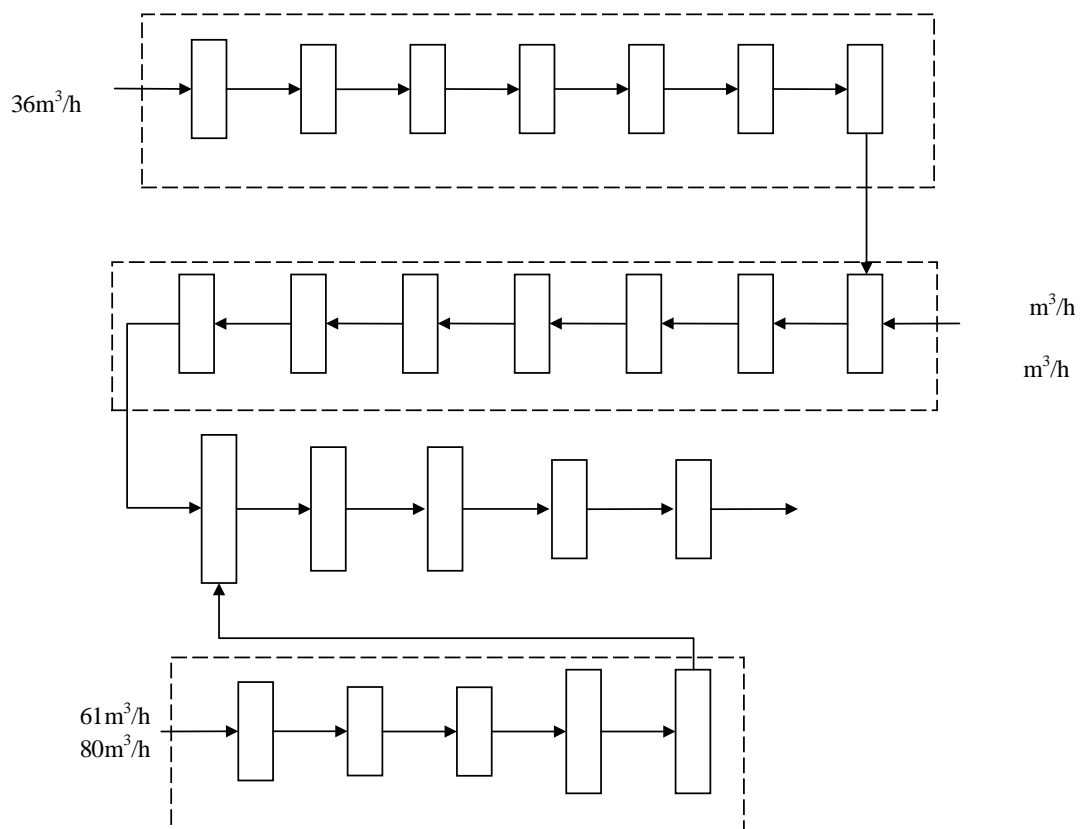

7.2.3

7.3

15dB(A)

7.4

7.4.1

7.4.2

7.4.3



7.5

7.5.1

"

"

7.5.2

"

"

"

"

"

"

"

"

7.5.3

7.5-1

| | | | | |
|--|---|--|--|--|
| | | | | |
| | | | | |
| | - | | | |
| | | | | |

$^{-7}$ cm/s

-

$^{-7}$ cm/s

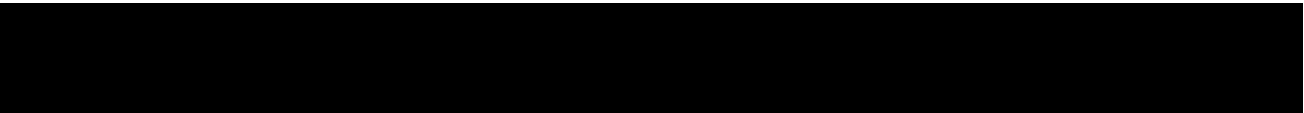

8

8.1

8.2

8.3

8.3.1

8.3.2

9

9.1

9.1.1

9.1.2









9.1.3

9.1.4

" "

9.2

| | | | |
|--|--|--|--|
| | | | |
| | | | |
| | | | |

| | | | |
|---|--|---|--|
| | | | |
| 1 |  |  | |
| 2 |  |  | |
| 3 |  |  | |
| 4 |  |  | |
| 5 | |  | |

9.3

| | | | | | | | | |
|--|--------|--------------------------|-----------------|-----------|------|-------|-------|--------------|
| | | | | | | | | |
| | 5# () | | | + +25m | 0.8 | 0.081 | 0.634 | GB28665-2012 |
| | DA127 | +40m ³ () | HCl | + +30m | 12.2 | 0.183 | 1.424 | |
| | DA125 | | | + +27m | 5.3 | 1.066 | 8.316 | |
| | DA126 | | HCl | + +40m | 20.7 | 0.393 | 3.065 | |
| | | | | | 3.8 | 0.071 | 0.556 | |
| | | | SO ₂ | | 35.7 | 0.678 | 5.29 | |
| | | | NO _x | | 40.7 | 0.774 | 6.038 | |
| | DA128 | | | + +12m | 7.8 | 0.078 | 0.608 | |

9.4

9.5

9.5.1

| | | | | |
|--|------|----------|-----|----------------|
| | | | | |
| | ZK04 | pH Hg | 1 1 | GB/T14848-2017 |

9.5.2

| | | | | |
|--|------|--|-----|--------------|
| | | | | |
| | | | 1 1 | GB28665-2012 |
| | | HCl | | |
| | | HCl SO ₂ NO _x | | |
| | | | | |
| | 1720 | HCl | | |
| | | A | | GB12348-2008 |

9.6 "

"

| | | | | | |
|--|-----|----------|--------|--------------|----|
| | | | | | |
| | | | 301 | | |
| | | | | GB13456-2012 | |
| | | | + +25m | GB28665-2012 | 25 |
| +40m ³ | HCl | + +30m | | | |
| | | + +27m | | | |
| | | + +12m | | | |
| HCl SO ₂ NO _x | | + + +40m | | | |

GB18599-2001

10

10.1

10.2

GB3096-2008

3

10.3



10.4

10.5

10.6

10.7

10.8

“ ”